

# Angus

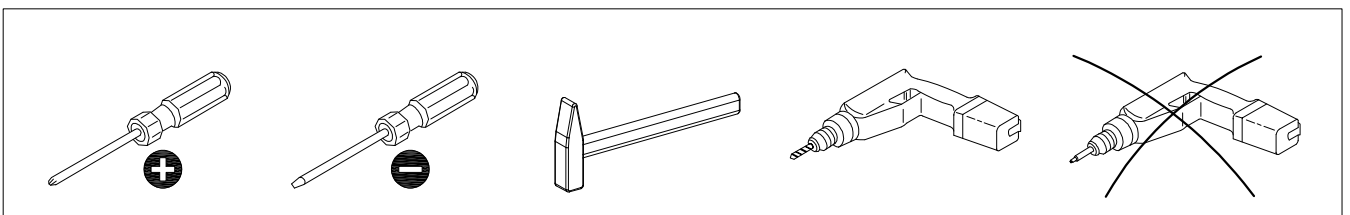

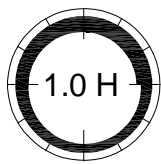

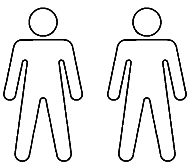

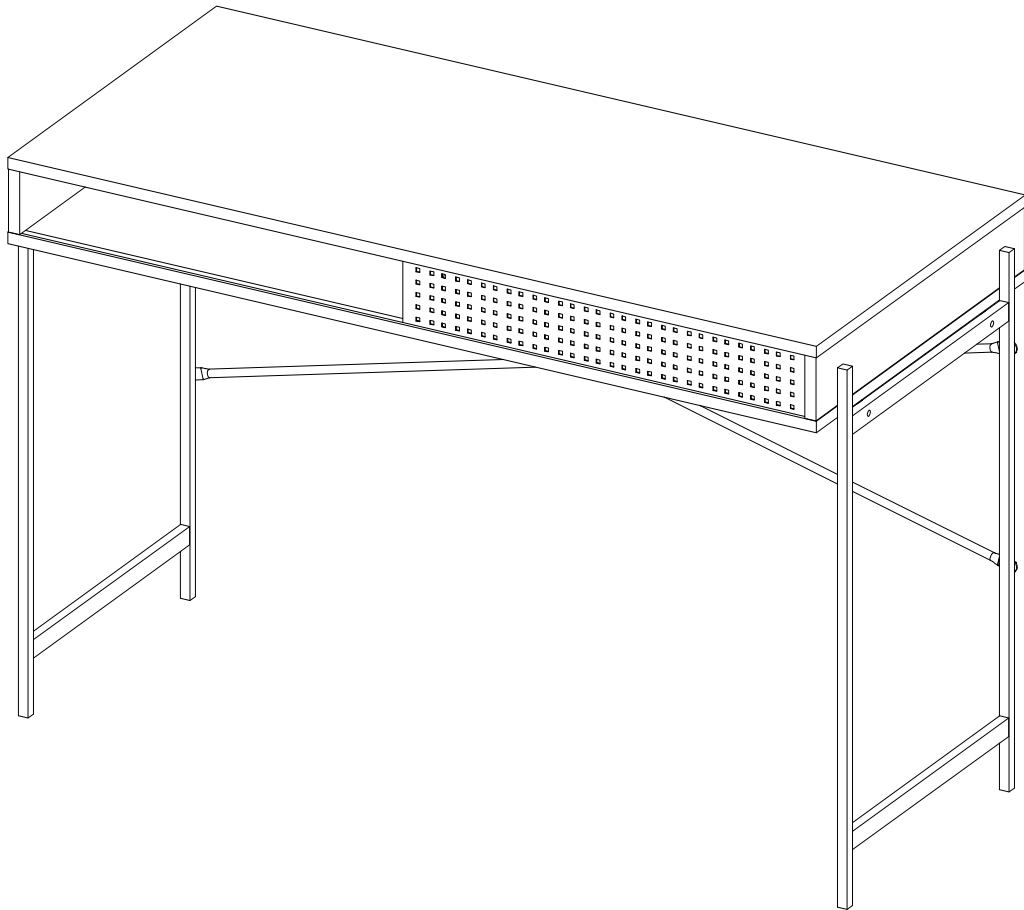

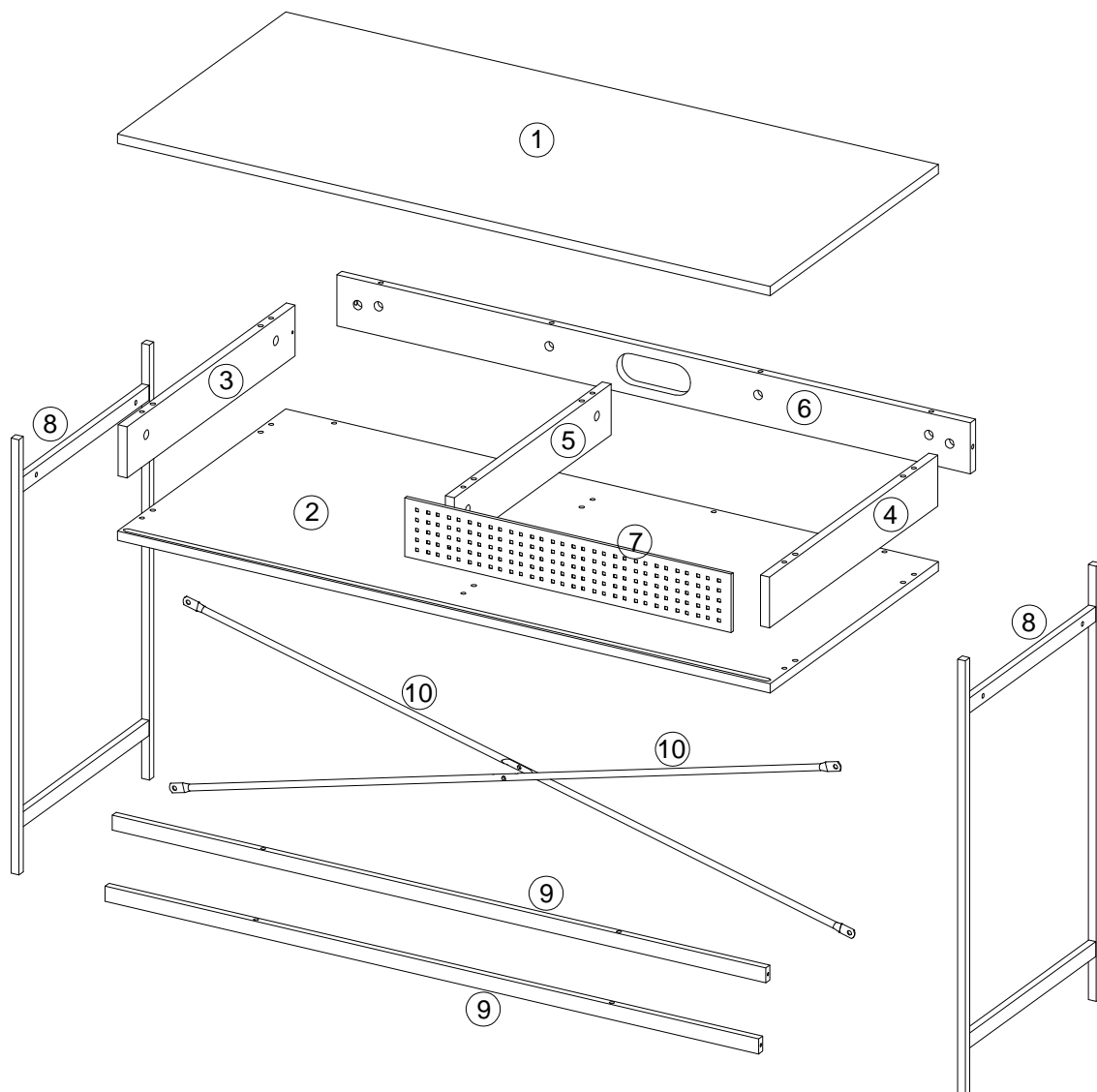

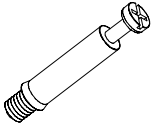

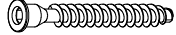

17/02/2022



			✓
①	1	1100x500x15	
②	1	1100x500x15	
③	1	499x82x15	
④	1	499x82x15	
⑤	1	466x82x15	





			✓
⑥	1	1068x82x15	
⑦	1	550x92x6	
⑧	2	700x401x13	
⑨	2	1102x24x12	
⑩	2	1166x10x10	



<p>A x 12</p>  <p>M6 x 45</p>	<p>B x 12</p>  <p>Ø15 x 12mm</p>	<p>C x 12</p>  <p>Ø8 x 30mm</p>	<p>D x 10</p>  <p>M7 x 38</p>	<p>E x 8</p>  <p>M6 x 35</p>
<p>F x 4</p>  <p>M6 x 10</p>	<p>G x 1</p>  <p>M6 x 20</p>	<p>H x 1</p>  <p>M6</p>	<p>J x 1</p>  <p>4mm</p>	<p>K x 6</p>  <p>Ø20</p>
<p>L x 2</p>  <p>3.5 x 16</p>	<p>M x 4</p>  <p>Ø16/Ø6</p>	<p>N x 2</p>  <p>L=100mm</p>	<p>P x 1</p>  <p>M6</p>	



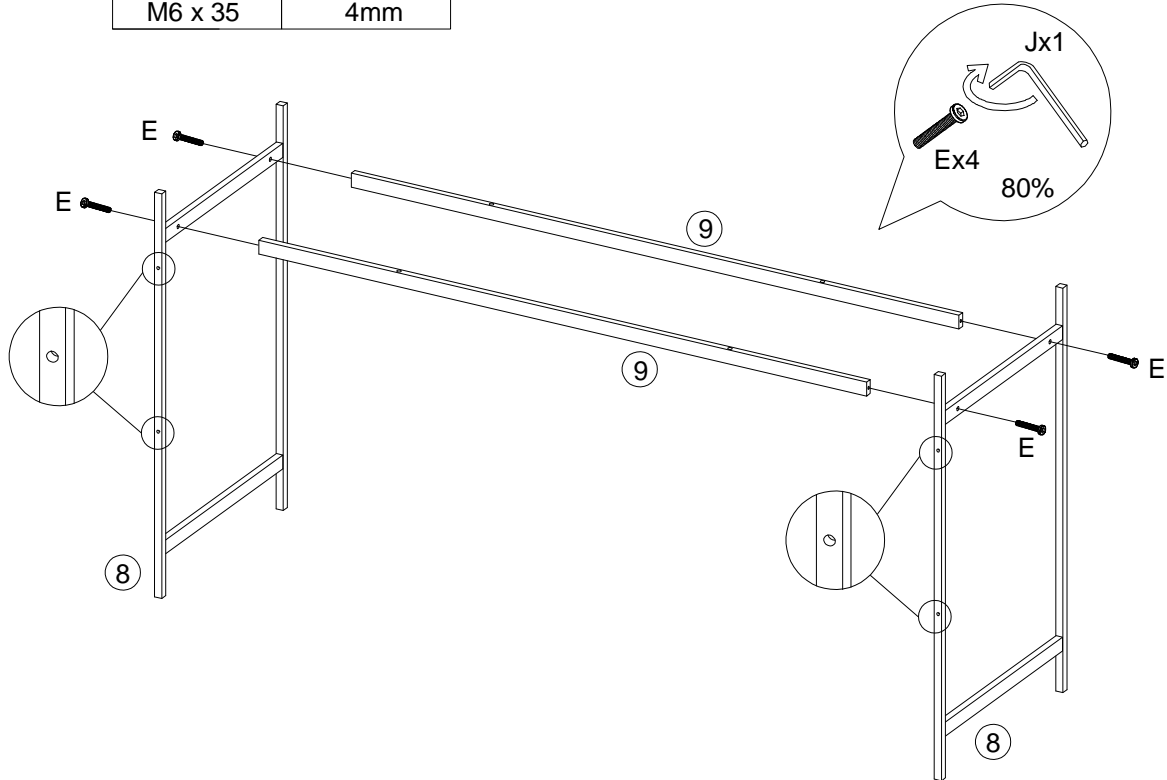

# 1

E x 4  M6 x 35	J x 1  4mm
---	---





	E  M6x35mm	F  M6x10mm	G  M6x20mm
---	---	---	---



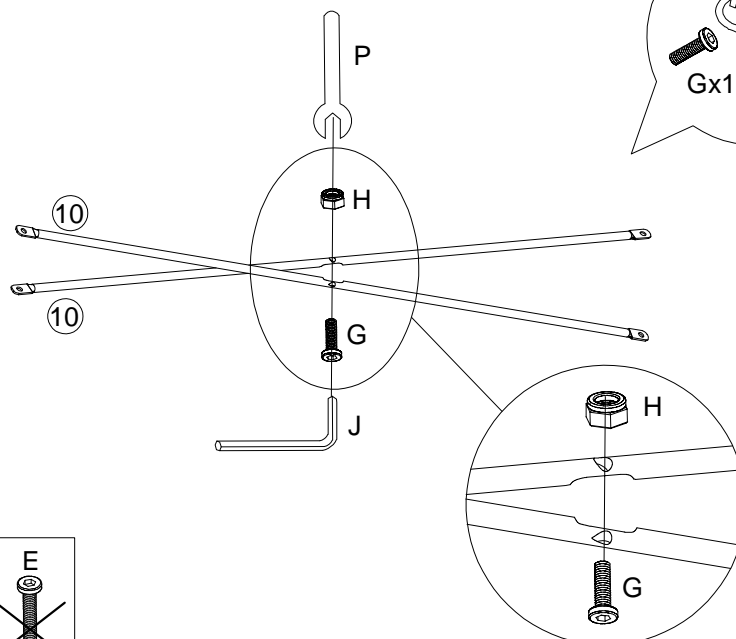
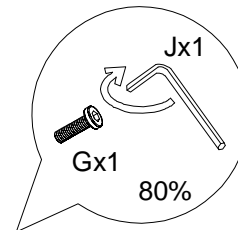

# 2

G x 1  M6 x 20	H x 1  M6	J x 1  4mm	P x 1  M6
---	--	---	--





	G  M6x20mm	F  M6x10mm	E  M6x35mm
---	---	---	---

# 3

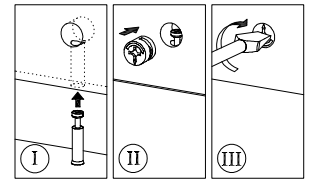
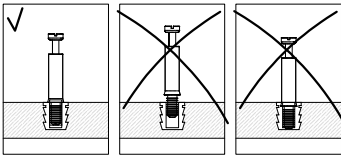
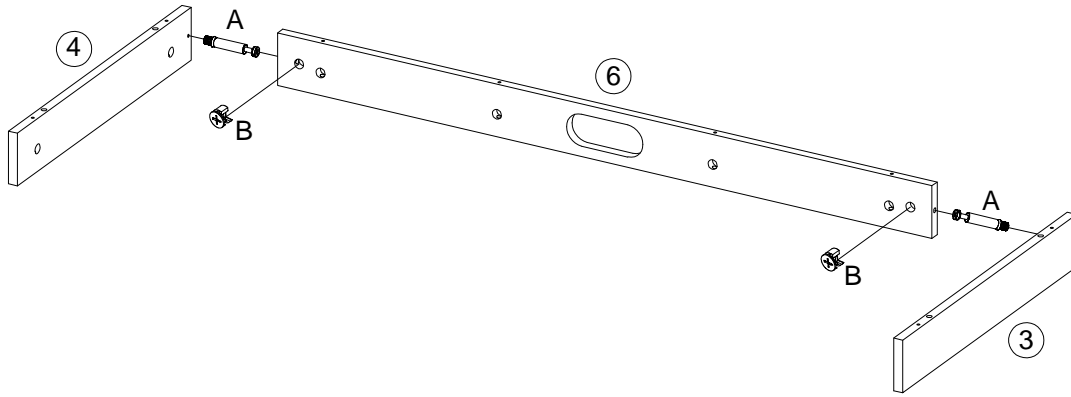
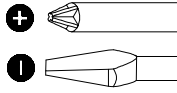
A x 2  M6 x 45	B x 2  Ø15 x 12mm
---	--



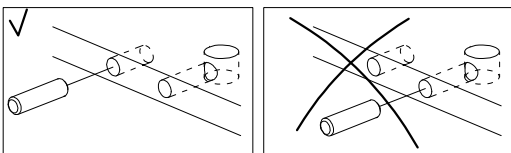
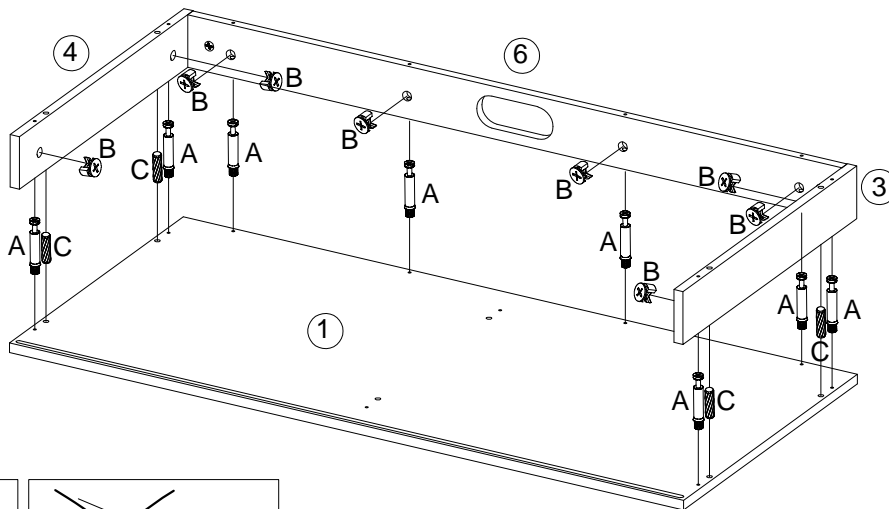
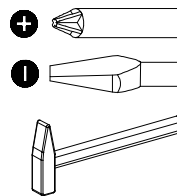

# 4

A x 8  M6 x 45	B x 8  Ø15 x 12mm	C x 4  Ø8 x 30mm
---	--	---





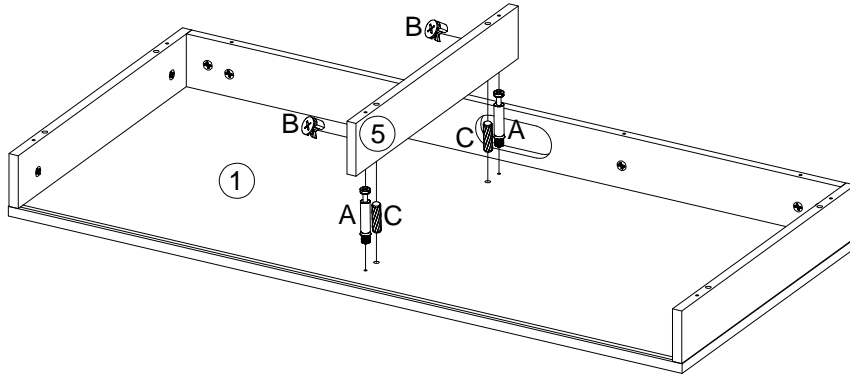
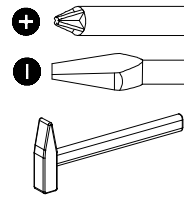

# 5

A x 2  M6 x 45	B x 2  Ø15 x 12mm	C x 2  Ø8 x 30mm
---	--	---



# 6

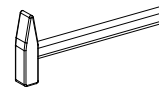

C x 6  Ø8 x 30mm	D x 10  M7 x 38	J x 1  4mm	K x 6  Ø20
---	--	---	---



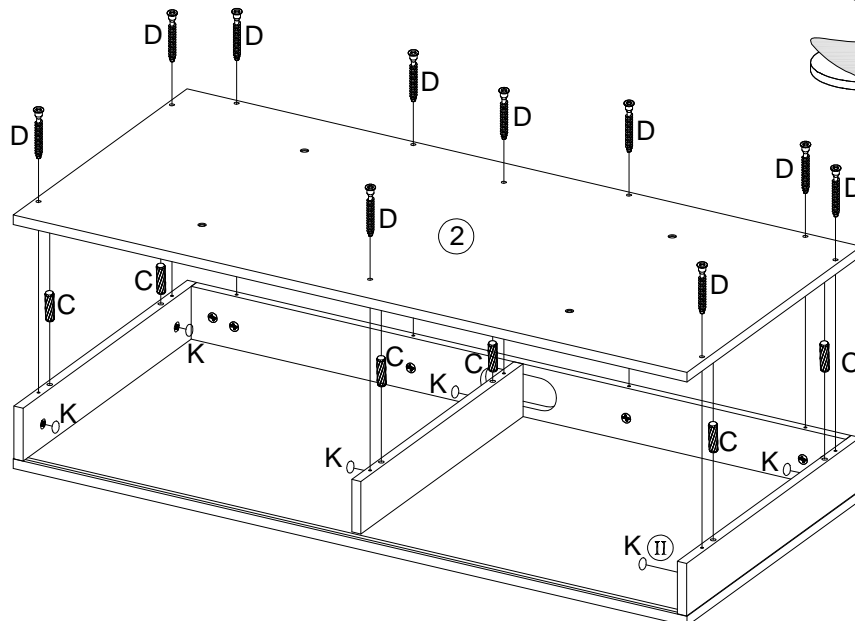



K (I)





# 7



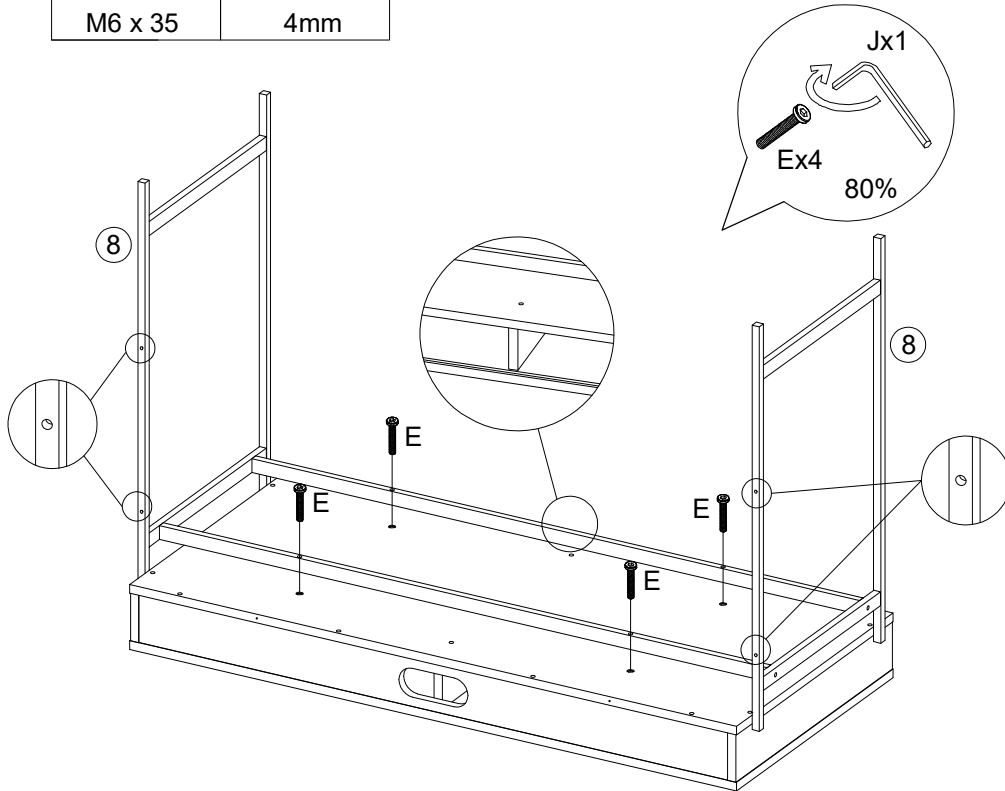

E x 4	J x 1
	
M6 x 35	4mm

	E	F	G
			
	M6x35mm	M6x10mm	M6x20mm





# 8

F x 4	J x 1
	
M6 x 10	4mm

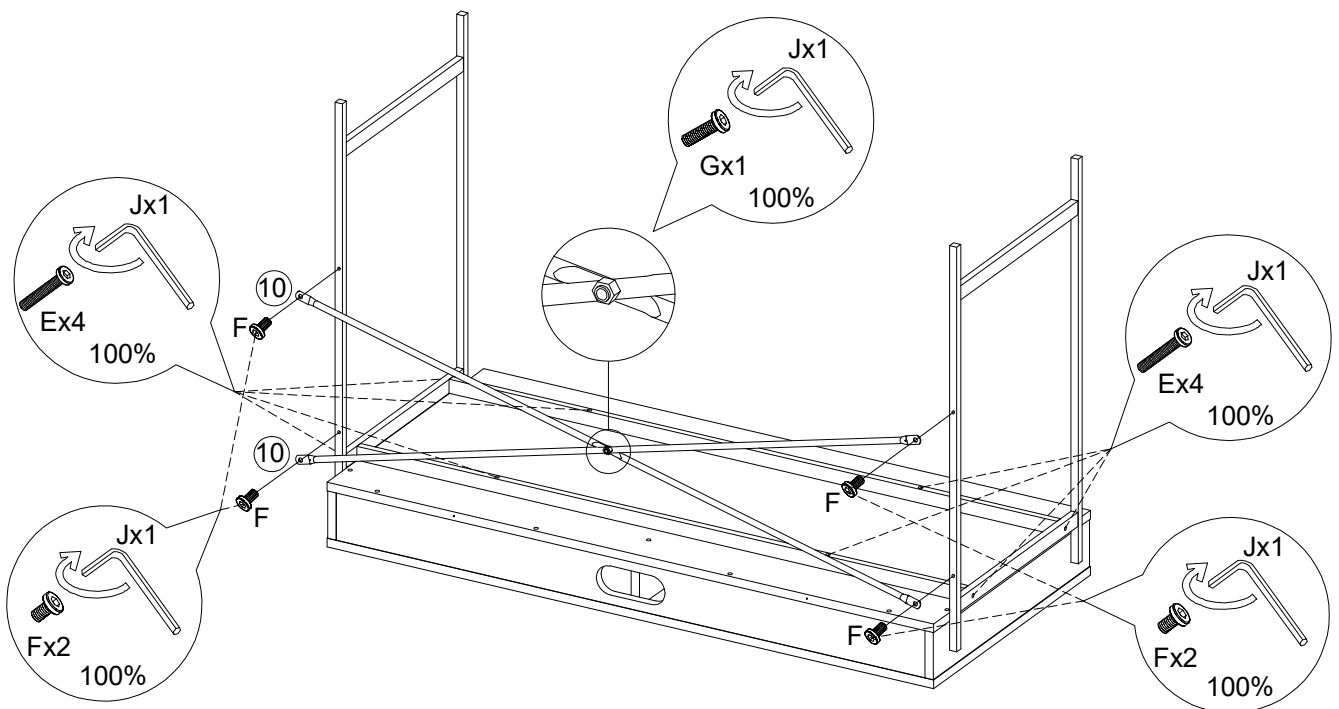
	F	G	E
			
	M6x10mm	M6x20mm	M6x35mm



# 9

L x 2	M x 2	N x 2
		
3.5 x 16	Ø16/Ø6	L=100mm

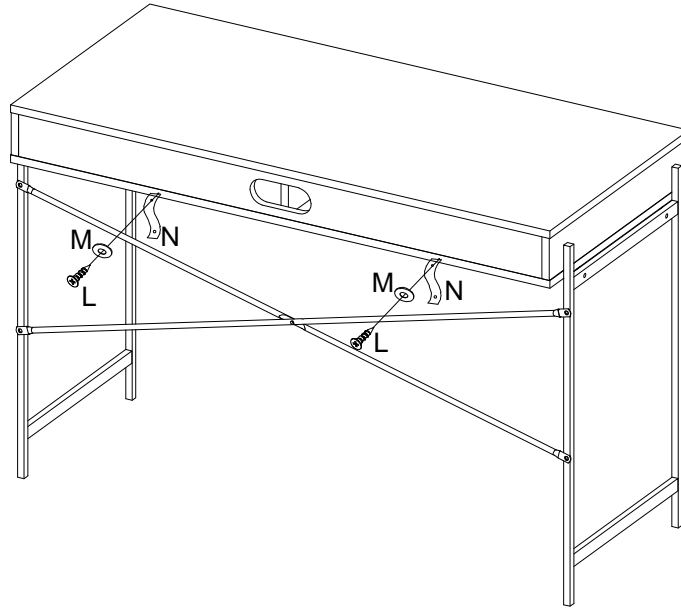

# 10

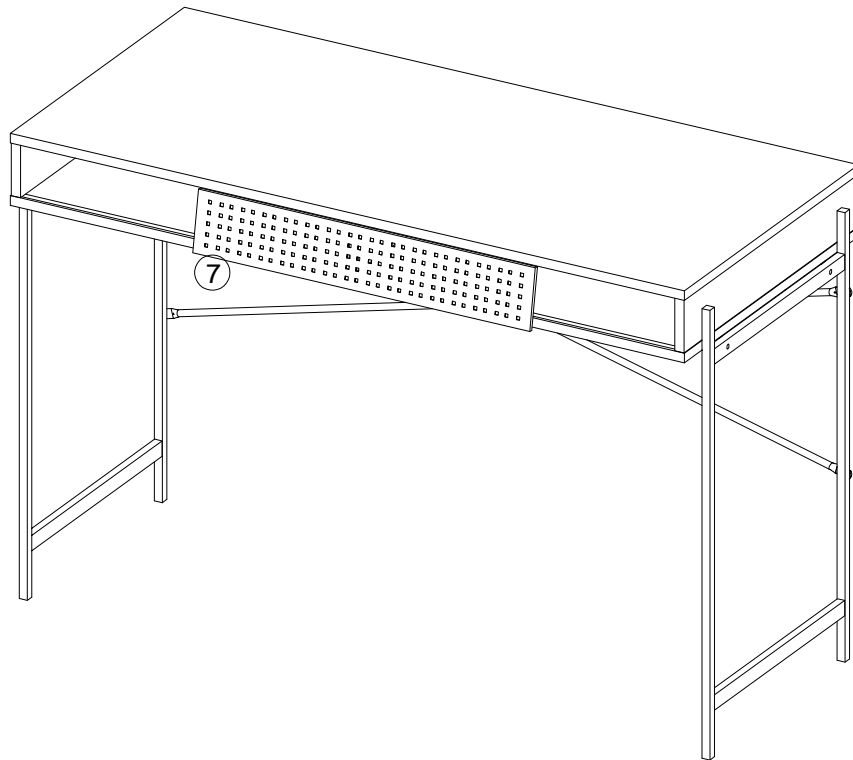



# 11

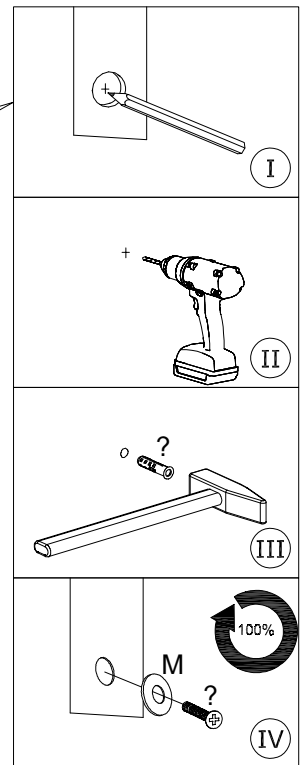
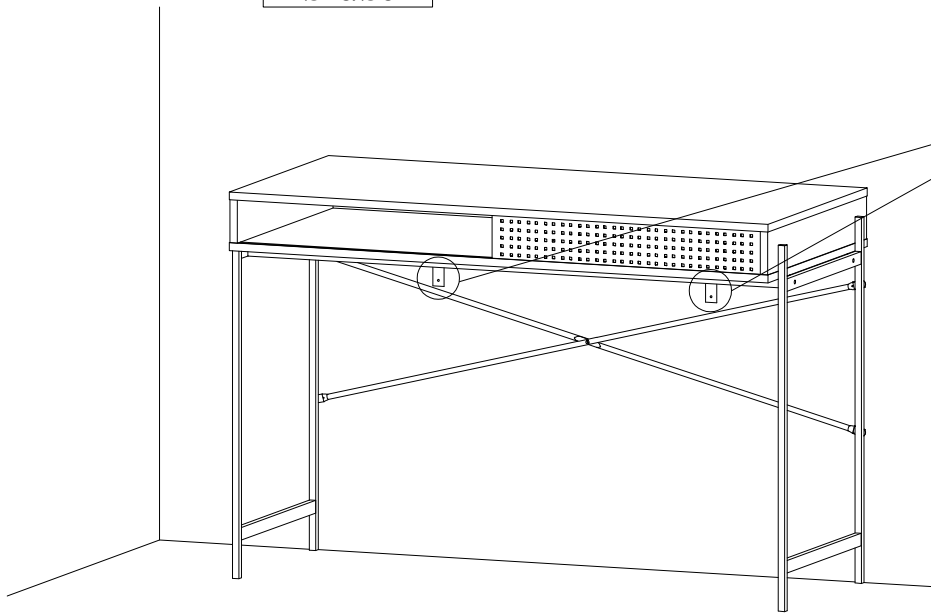
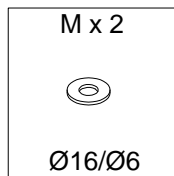

# 12

