

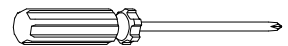

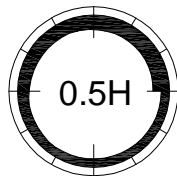

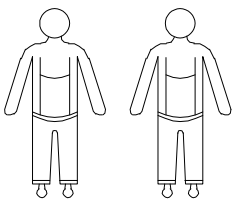

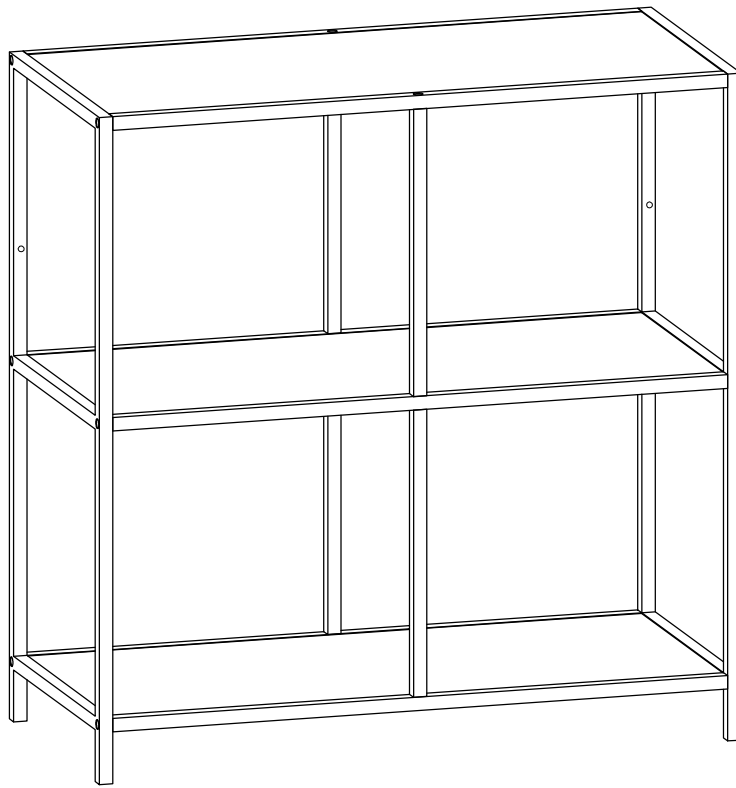

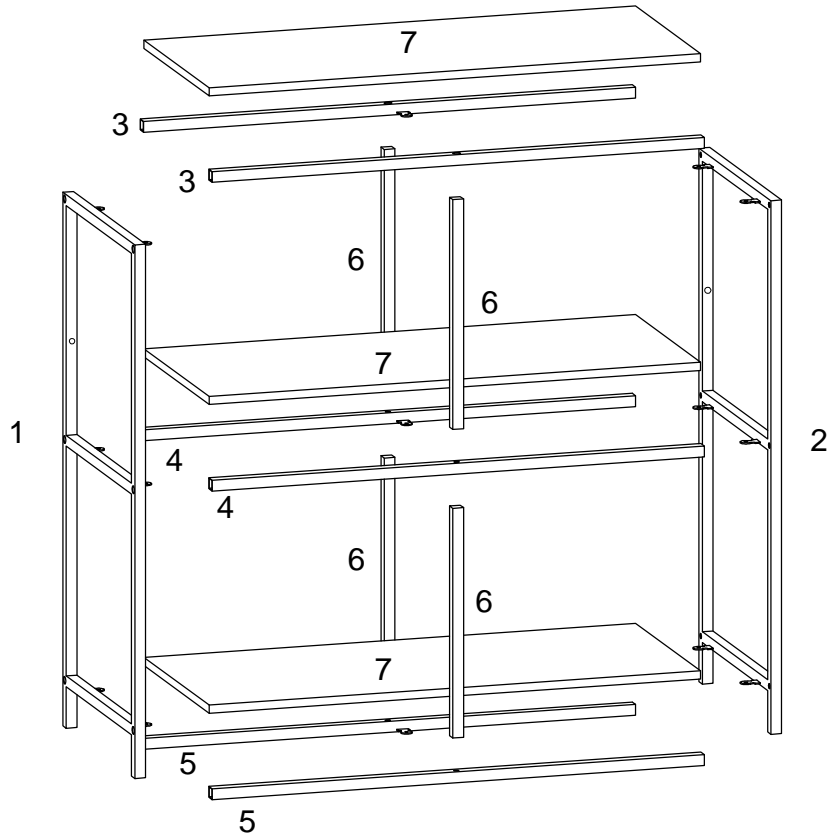

Seaford







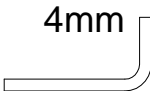

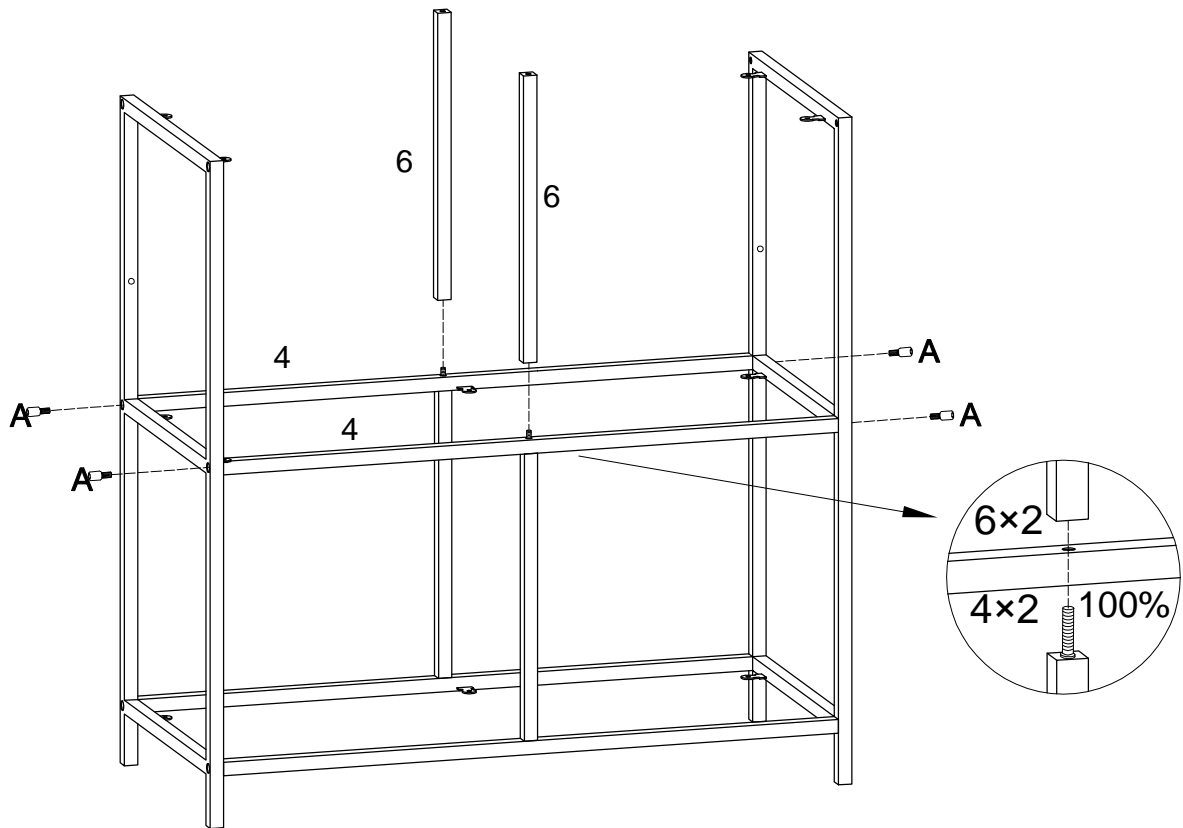
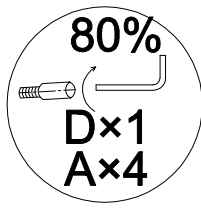
1  1PC	2  1PC	3  2PCS
4  2PCS	5  2PCS	6  4PCS
7  3PCS		

A M6×15mm  16PCS	B M6×55mm  2PCS	C M4×12mm  18PCS	D 4mm  1PC
--------------------------------------------------------------------------------------------------------------	-------------------------------------------------------------------------------------------------------------	--------------------------------------------------------------------------------------------------------------	----------------------------------------------------------------------------------------------------------

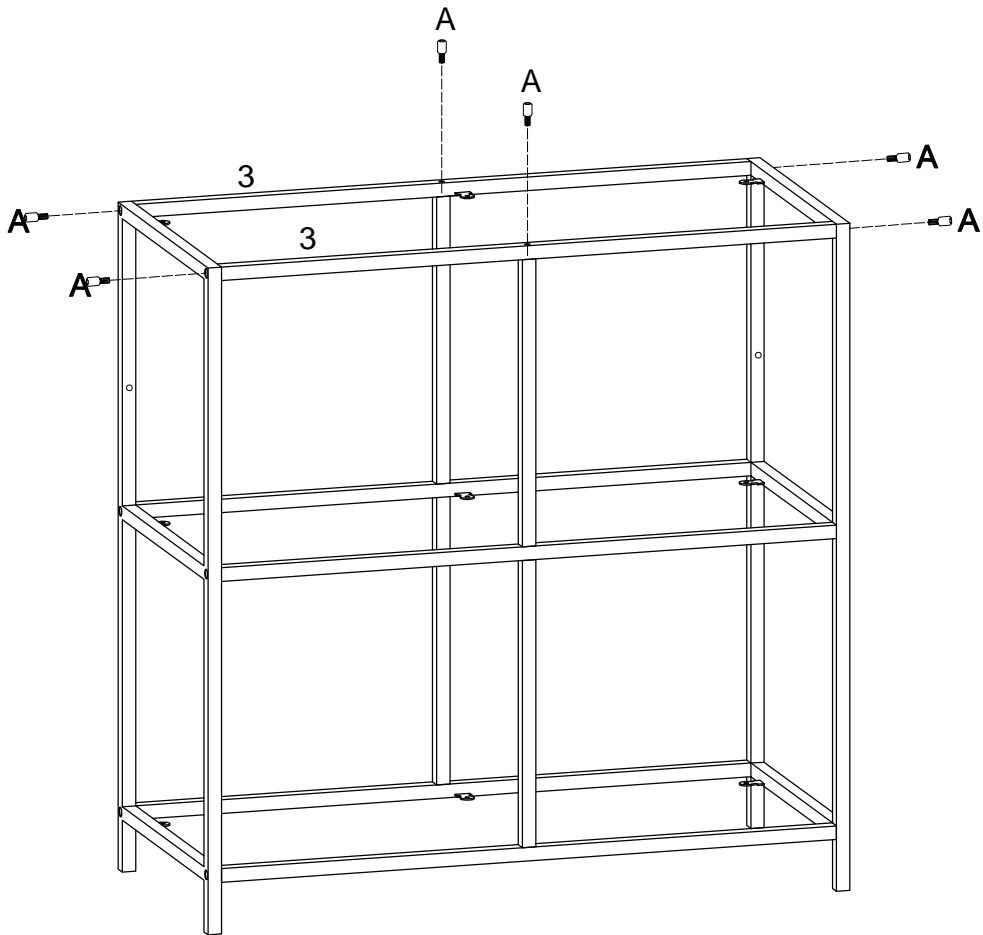
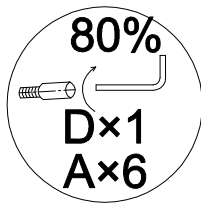

<p>A M6×15mm</p>  <p>4PCS</p>	<p>D 4mm</p>  <p>1PC</p>
--------------------------------------------------------------------------------------------------------------------------	----------------------------------------------------------------------------------------------------------------------



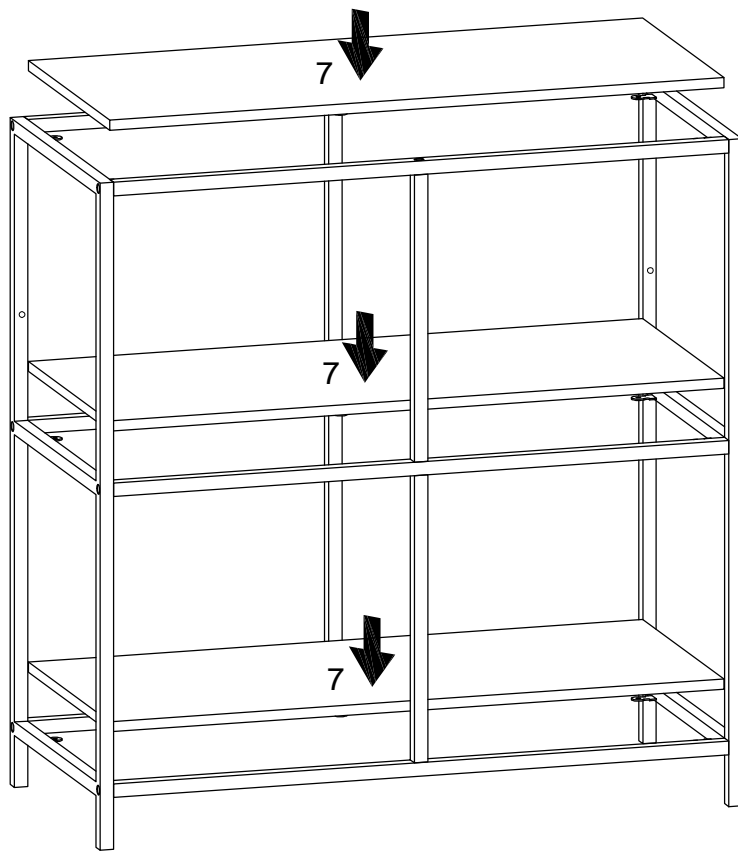

A M6×15mm  6PCS	D 4mm  1PC
---------------------------------------------------------------------------------------------------------------------	-----------------------------------------------------------------------------------------------------------------

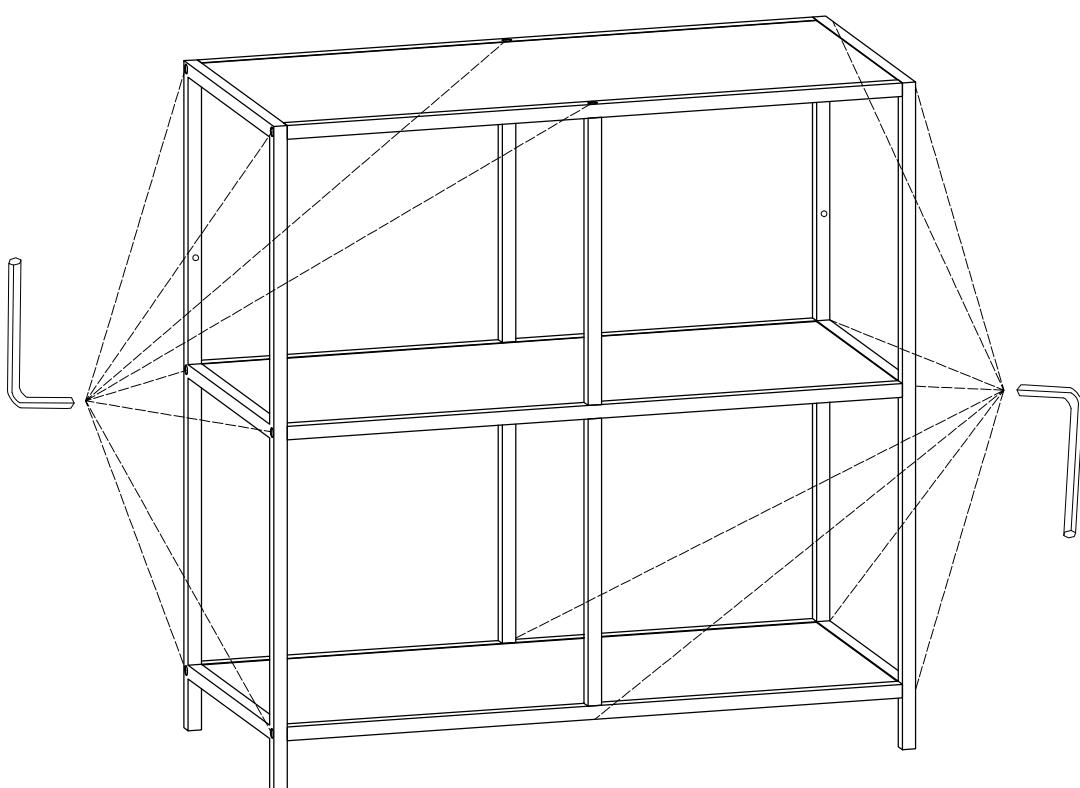
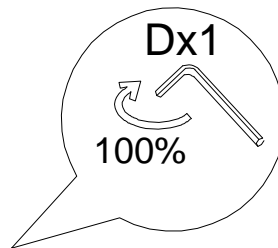

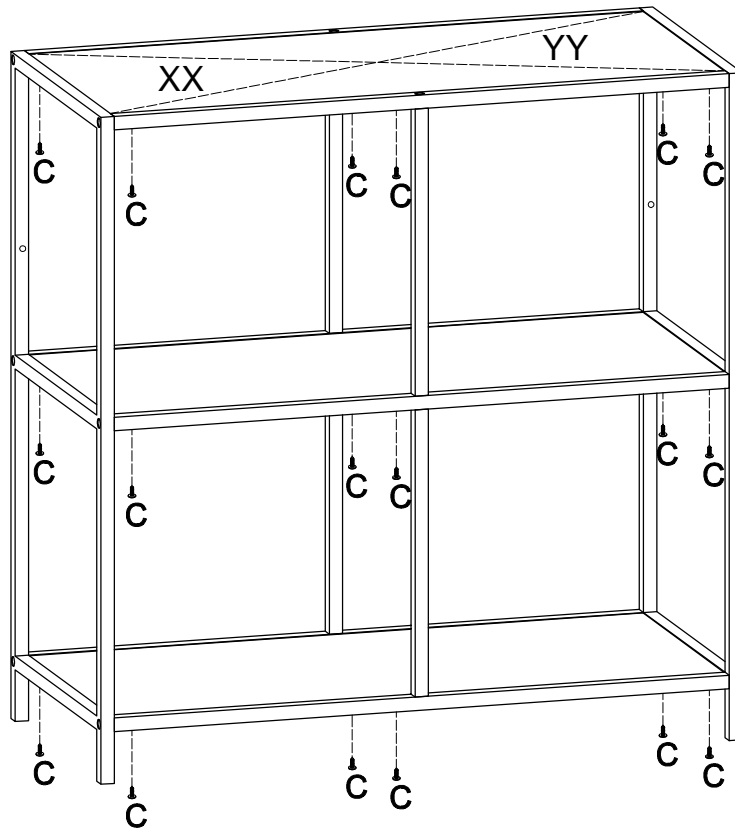
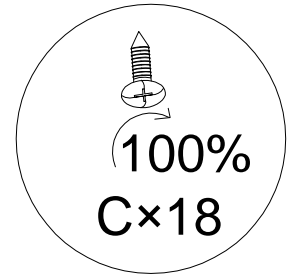

! XX=YY



C M4×12mm

18PCS

