

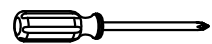

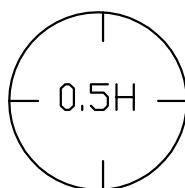

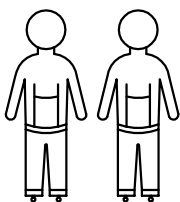

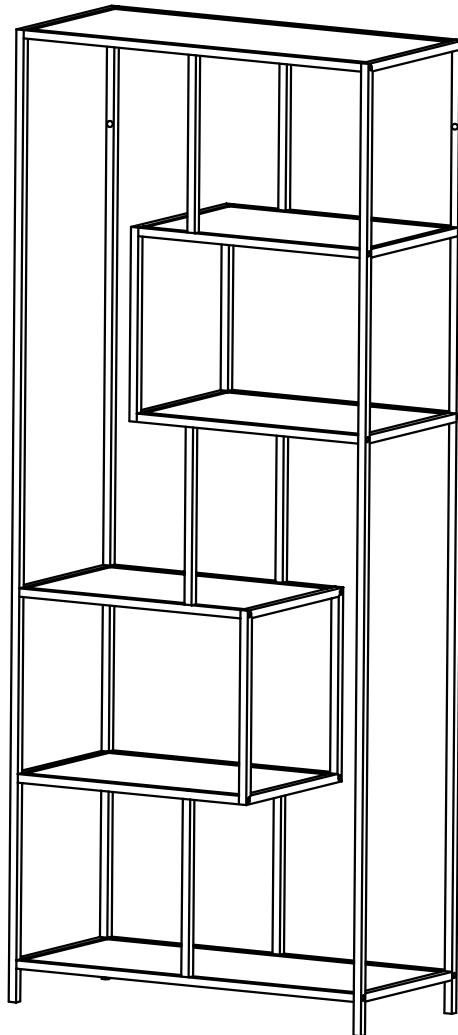

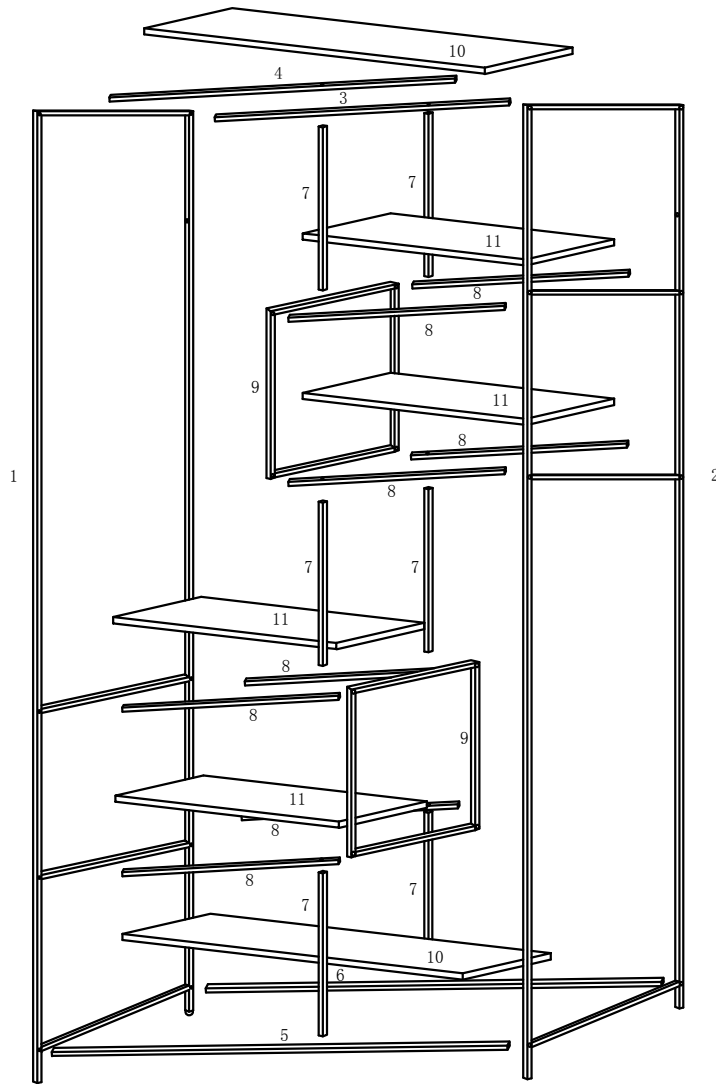
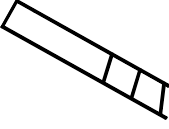
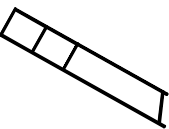





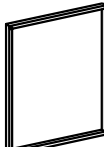

Seaford

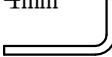





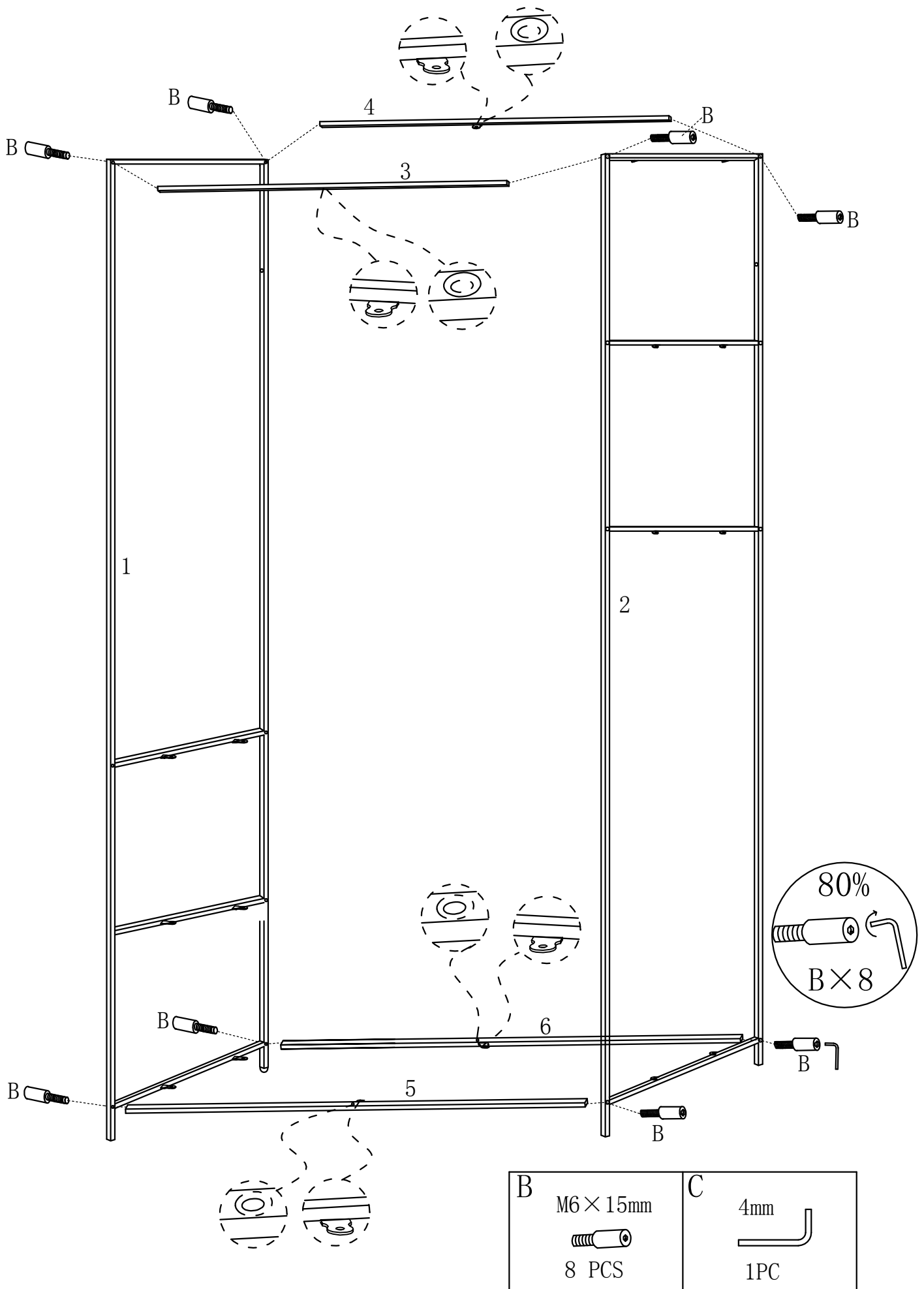

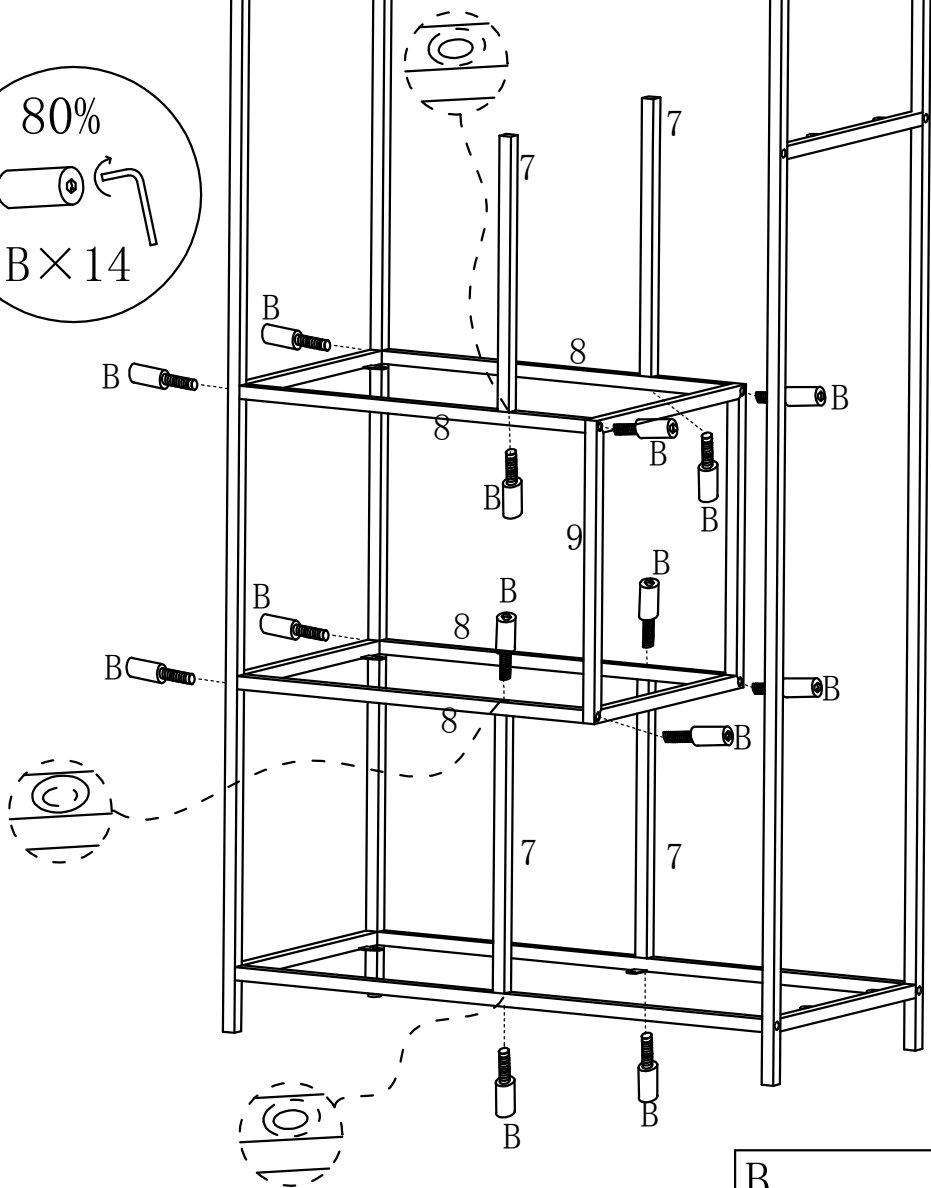
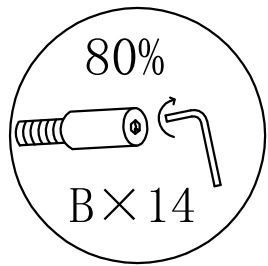
1  1PC	2  1PC	3  1PC	4  1PC	5  1PC
6  1PC	7  6PCS	8  8PCS	9  2PCS	10  2PCS
11  4PCS	A M4×10mm  28PCS	B M6×15mm  36PCS	C 4mm  1PC	D M4×22mm  2PCS
E  2PCS	F M4mm  2PCS	G ∅13*∅5mm  2PCS	H 3mm  1PC	I M4mm  1PC

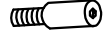

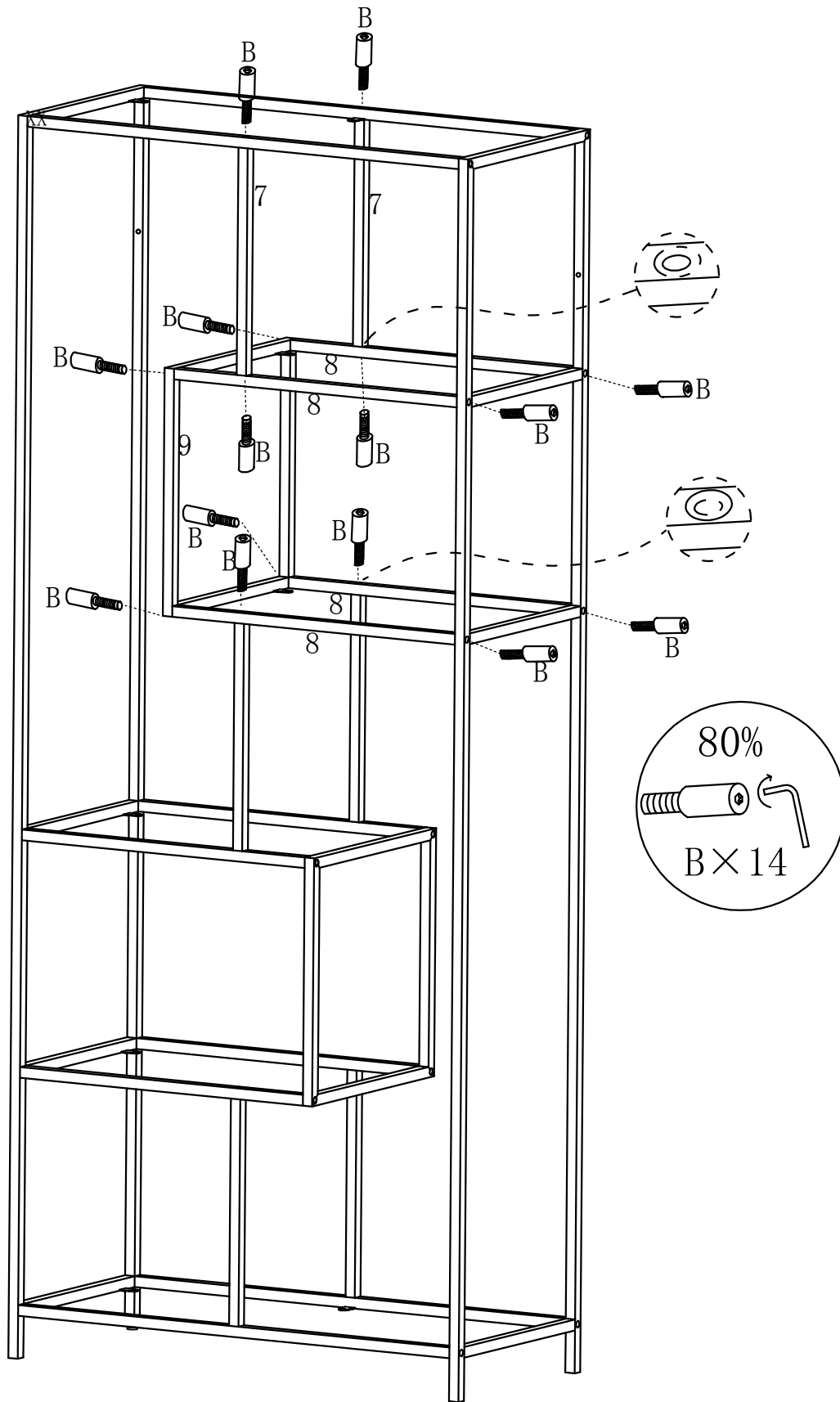

<p>B M6 × 15mm  14 PCS</p>	<p>C 4mm  1PC</p>
--	---

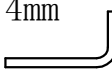

<p>B M6 × 15mm  14 PCS</p>	<p>C 4mm  1PC</p>
--	--

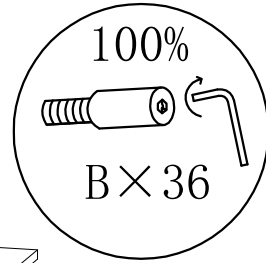



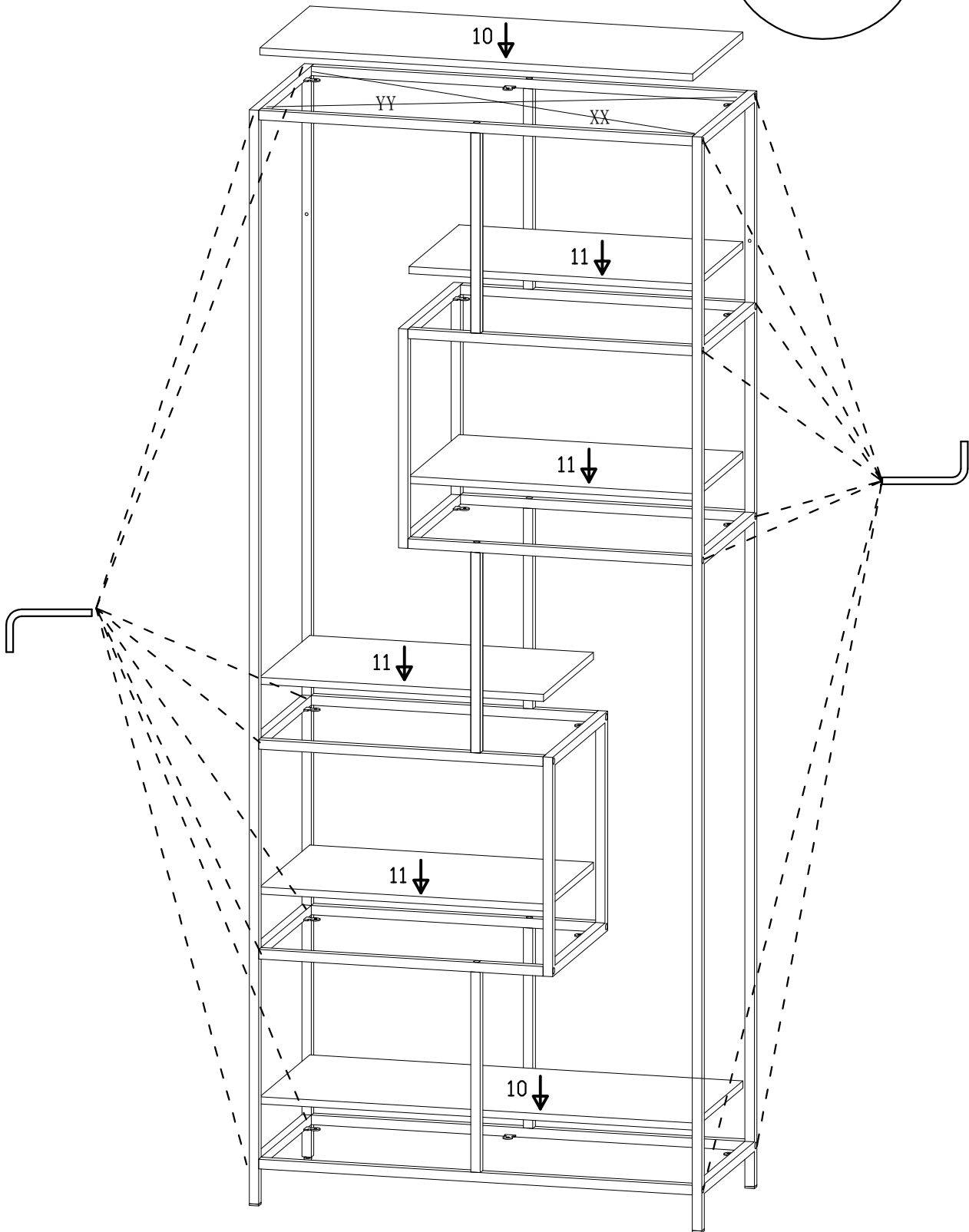

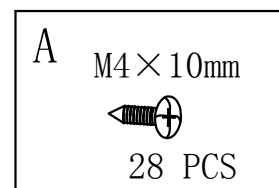
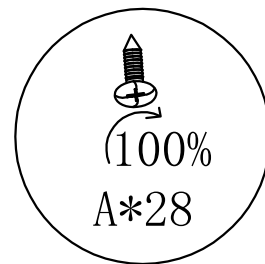
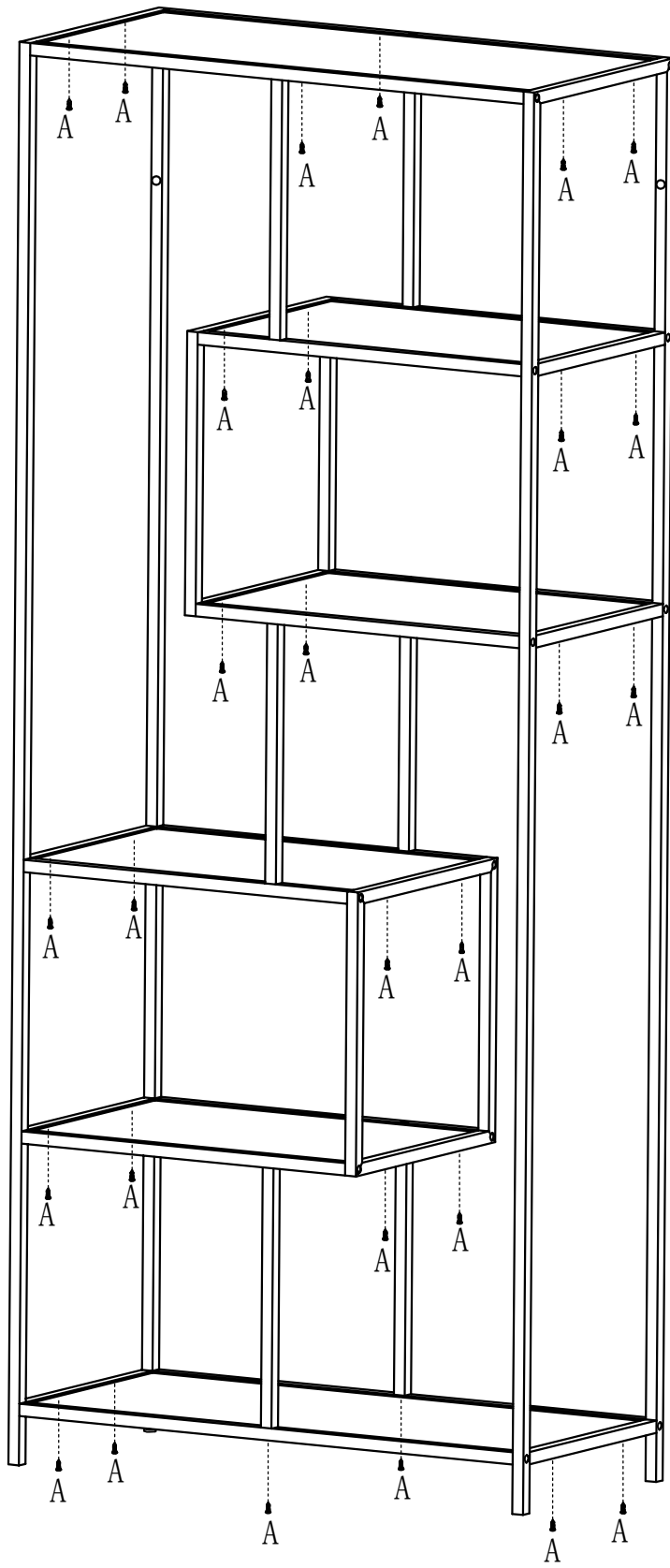

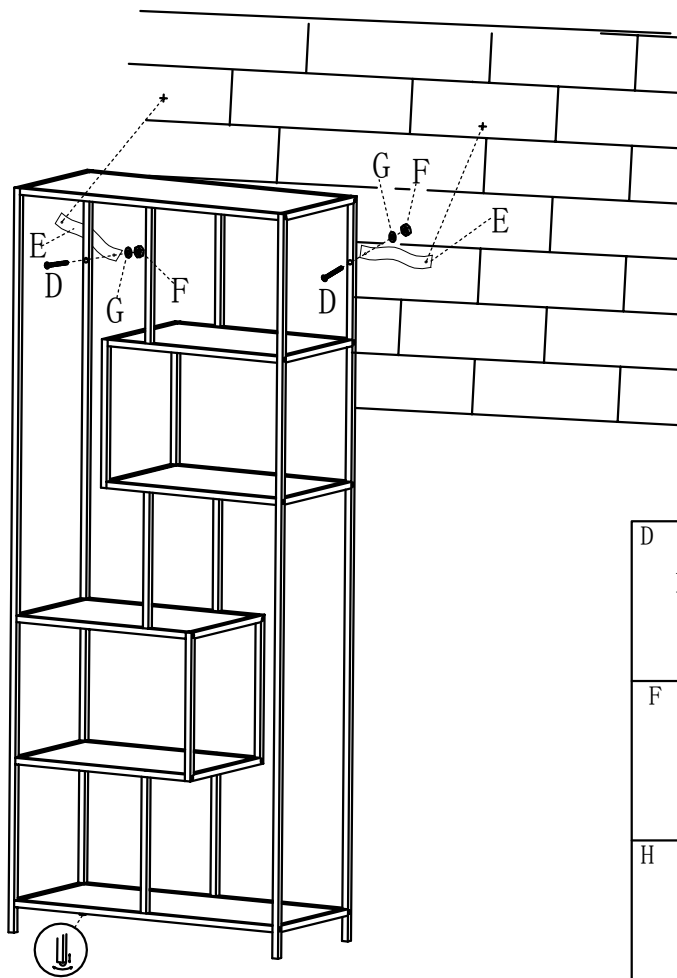
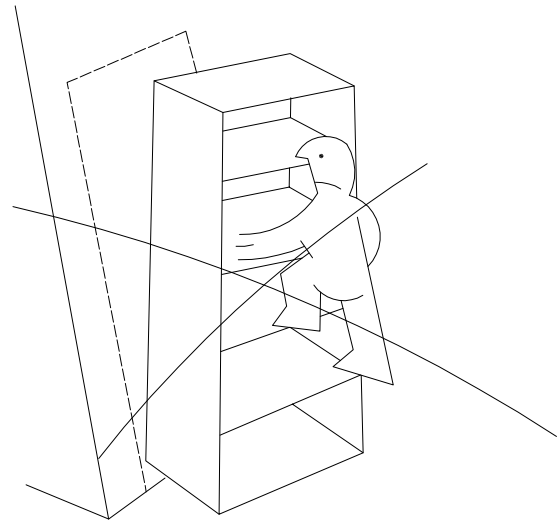
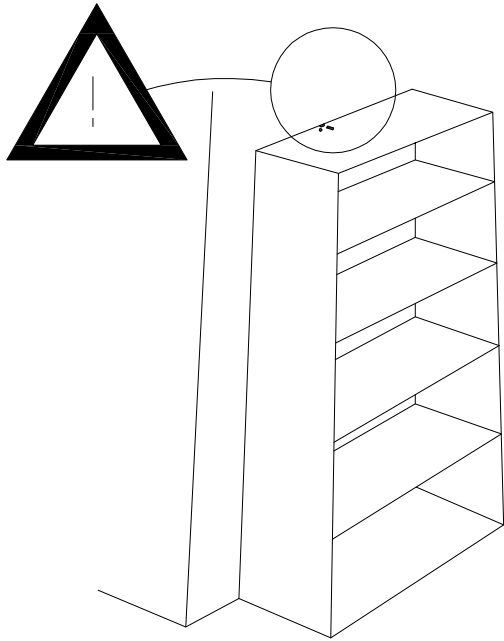
⚠ XX=YY







<p>D</p> <p>M4 × 22mm</p>  <p>2PCS</p>	<p>E</p>  <p>2PCS</p>
<p>F</p> <p>M4mm</p>  <p>2PCS</p>	<p>G</p> <p>∅13*∅5mm</p>  <p>2PCS</p>
<p>H</p> <p>3mm</p>  <p>1PC</p>	<p>I</p> <p>M4mm</p>  <p>1PC</p>