

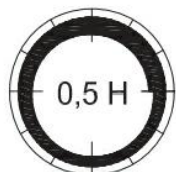

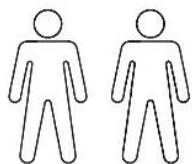

# ALISMA-coffee table

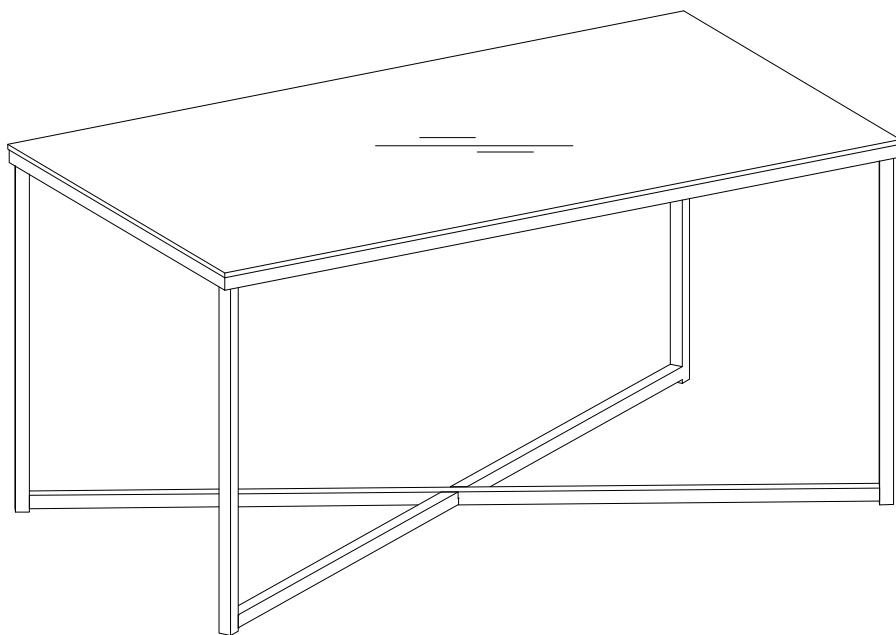

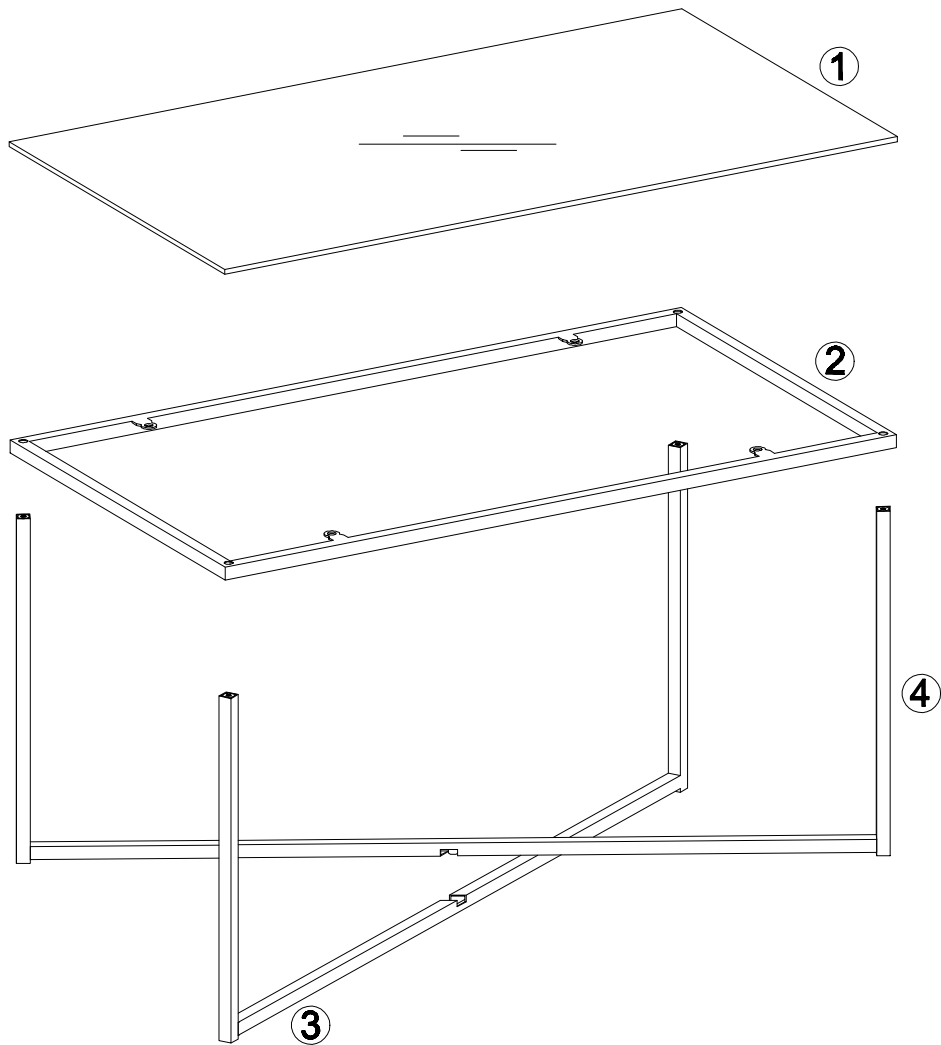

2/7/2020

1	1	900x500x6	
2	1	898x498x16	
3	1	1013x425x16	
4	1	1013x425x16	



<b>A x 4</b>  <b>M6 x 30</b>	<b>B x 1</b>  <b>M6 x 8</b>	<b>C x 4</b>  <b>Ø30</b>	<b>D x 1</b>  <b>4mm</b>
---	--	---	---

# 1

<b>A x 4</b>  <b>M6 x 30</b>	<b>B x 1</b>  <b>M6 x 8</b>	<b>D x 1</b>  <b>4mm</b>
---	--	---

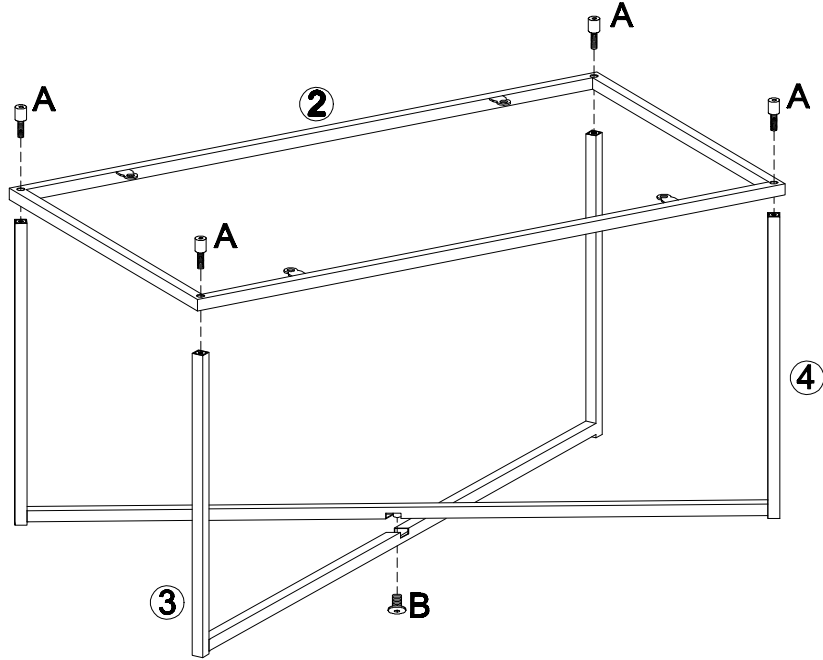

# 2

<b>C x 4</b>  <b>Ø30</b>
---

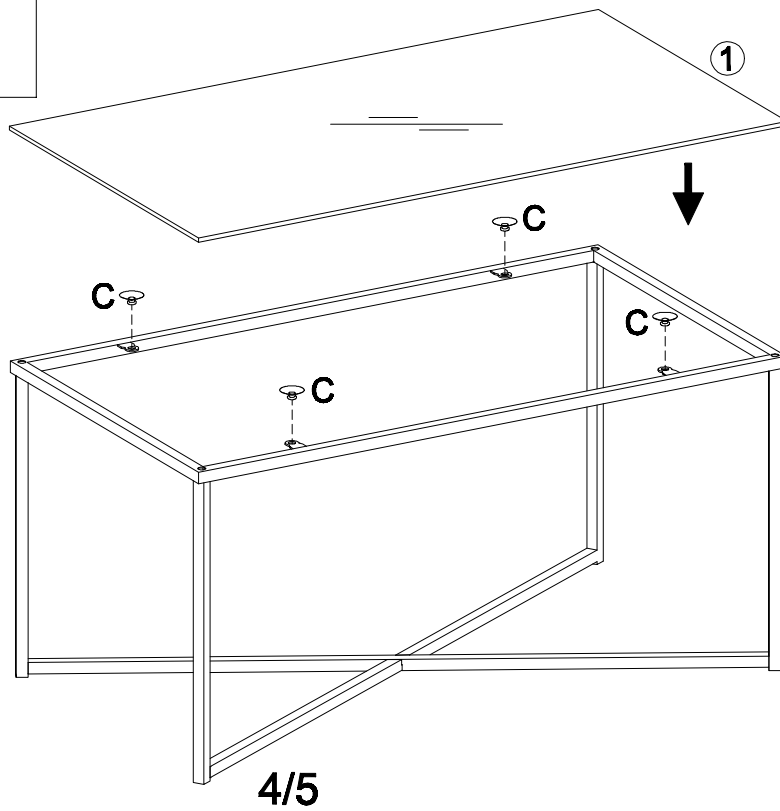

3

